

ISO 10303-238

CHARACTERISTICS, MATERIALS & TRACEABILITY HARMONIZATION.

Document Index

Introduction: Harmonization strategy.

Part 1: Characteristics harmonization.

Part 2: Materials harmonization.

Part 3: Process traceability proposal.

3.1 Adding Traceability Capabilities to NC-programs.

3.2 Tracing controller events.

3.3 Modeling process traceability proposal into AP238 ARM.

Part 4: Open Questions.

Part 5: Appendix:

A1: More Harmonization graphics

A2: Traceability Activity Model

Introduction: Harmonization strategy.

Characteristics are a wide concept, as each STEP-NC manufactured product may specify hundreds of different types of characteristics. Characteristics **must** be defined, registered, stored, audited, and validated.

So it is important to take into account that characteristics data is **BI-DIRECTIONAL**, flowing from design to manufacture and back again from manufacture to design. The downstream path in STEP-enabled manufacturing environments is already proposed for characteristics in frameworks as AP224, AP240 and other all-inclusive APs like 223 (tables below). Therefore, characteristics specification may be "harmonized" across these APs through the "properties" UOF.

AP224		
<i>Part Model</i>	<i>Shape Representation</i>	<i>Features</i>
<i>Properties</i>	<i>Tolerances</i>	<i>Materials</i>
<i>Process Control</i>	<i>Administrative Data</i>	<i>Requisitions</i>
<i>Process requirement Documents</i>		

Table I. AP224 defines administrative Data as Part Administration Data (Approval, Person & Organization and Orders).

AP240		
<i>Part Model</i>	<i>Shape Representation</i>	<i>Features</i>
<i>Properties</i>	<i>Tolerances</i>	<i>Materials</i>
<i>Machine tool Resources</i>	<i>Administrative Data</i>	<i>Process Plan & Process Activities</i>
<i>Process requirement Documents</i>		

Table II. AP240 defines process Requirement Documents as Contracts, Controller Program, Drawings and Illustrations, Specifications, Documents, and Machine Tool Resources as WorkStation, Work Cell, Machine.

AP223		
<i>Part Model</i>	<i>Shape Representation</i>	<i>Features</i>
<i>Properties</i>	<i>Tolerances</i>	<i>Materials & composition</i>
<i>Casting Requeriments</i>	<i>Administrative Data</i>	<i>Process Plan & Process Activities</i>
<i>Quality Control Records & Documents</i>	<i>Cast Process Simulation</i>	<i>Mold Design</i>

Table III. AP223 "all-inclusive" protocol

AP238		
		<i>Features</i>
	<i>Tolerances</i>	
	<i>Administrative Data (Management UOF)</i>	
	<i>Milling, Turning & EDM Processes (ISO 14649)</i>	

Table IV. Current AP238.

AP238		
		<i>Features</i>
	<i>Tolerances</i>	
<i>Properties (Characteristics Data)</i>	<i>Administrative Data (Management UOF)</i>	
<i>Traceability requeriments Data</i>	<i>Milling, Turning & EDM Processes (ISO 14649)</i>	

Table V. AP238 harmonization PROPOSAL for traceability & characteristics data.

PART 1. CHARACTERISTICS HARMONIZATION.

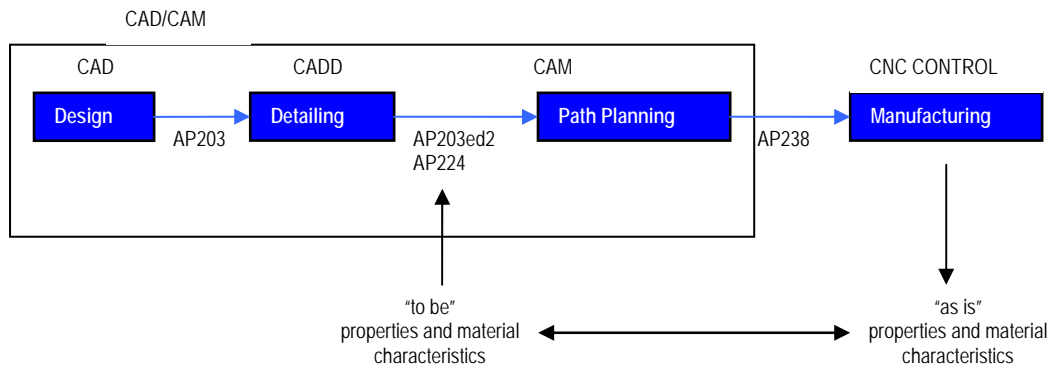

Figure 1. Bidirectional characteristics data.

Characteristics data is **Bi-Directional** (figure 1). Once characteristics are specified in the design, (AP224 could be used as input data for generating and configuring “to be” characteristics), these specifications would need to be translated into the corresponding AP238, to allow machine interpretation (instructions or workingsteps needed for characteristics recording – for example “touch_probing” instructions -). But, there are not placeholders for **automatic** registering the characteristics data (“as is” data). If STEP is supposed to integrate all information and avoid unnecessary data format translations in order to minimize information lost, characteristics data should also be **communicated back** in STEP format. As a proposal, properties could be used as place holders for registered characteristics data. That is, when a AP238 file goes to the controller, properties hold characteristics definitions (**to be**), while when a AP238 comes back from the controller (after machining), same properties would hold now the characteristic recorded data (**as is**).

So what its missing to harmonize characteristics into AP238?. **Products characteristics** could be referred to product, and so, they could be ARM-linked with the “workpiece” entity representing the product version, in the same fashion AP223,224,240 **property_characteristics**, linked to Part entity. This could be defined in the new harmonized characteristic model as **its_traceable_charectistics** (figure 2), an optional unbounded set of AP223, AP224, AP240 harmonized “**property**” entities¹.

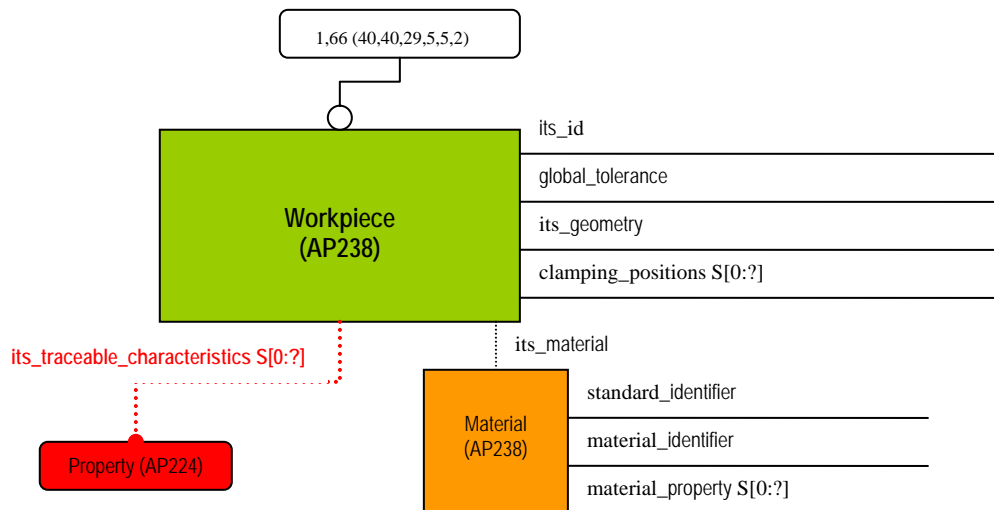

Figure 2. Proposed entry point for traceable_characteristics in AP238.

¹ Valid for all document figures.

■ Green:	Entities already present in the original AP model.
■ Red:	New entities proposed for “Traceability & Charaectiristics” in AP238
■ Orange:	AP harmonized entities, needing some redefinition, like “sub-typing”, or “super-typing”, for harmonization between AP, or to add new attributes to cover new information requirements.
■ Gray	Attributes or entities not necessary in AP238 scope.

Figure 3 presents the proposed harmonized data model for characteristics in AP238, harmonized with the properties concept of other manufacturing STEP APs, and adding place for specific information requirements, as for instance characteristics properties associated with features and workingsteps.

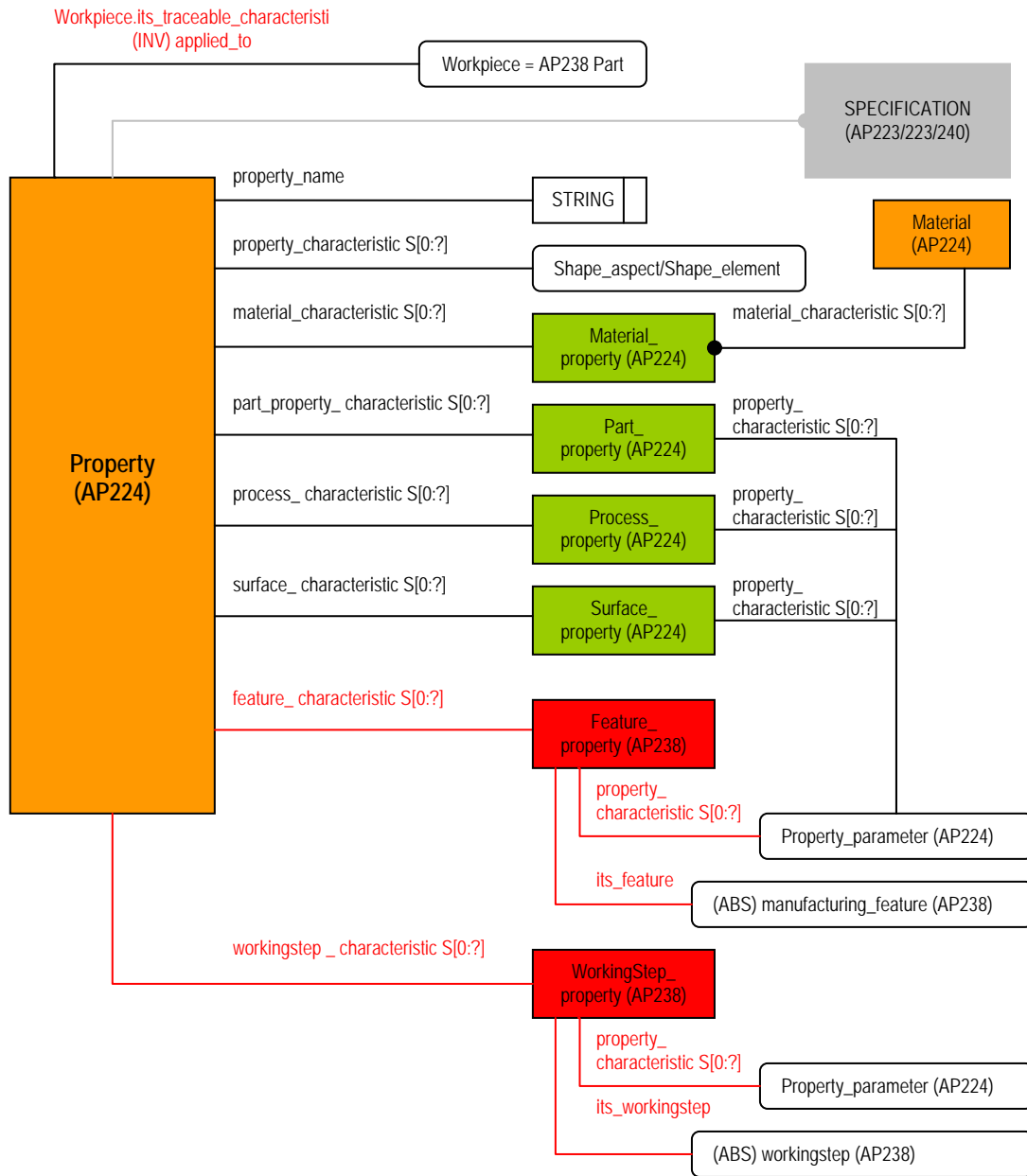

Figure 3. Proposal for "characteristics" information requirements in AP238 (AP223,224 & 240 harmonized).

PART 2. MATERIALS HARMONIZATION.

Material properties can be regarded as an “special” kind of product characteristics. AP238 covers material properties with the “**material_property**” attribute of the “**material**” entity included in the “**workpiece**” UOF (figure 4), but in a limited fashion, as these are modeled as a set of “**property parameter**”.

Materials data covers both characteristics and general traceability information (as raw material lot id), so it would necessary harmonize the material concept between APs, but also extend it by adding some extra information requirements.

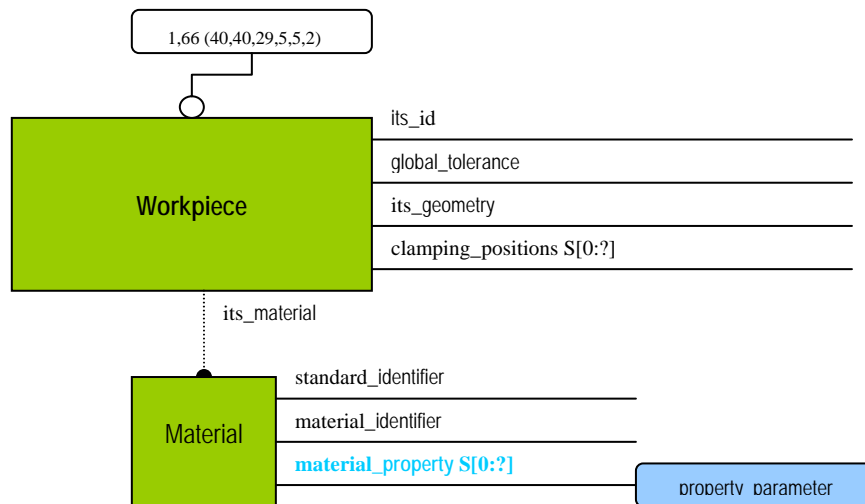

Figure 4. Material Entity from AP238 workpiece UOF.

Part & Materials properties defined in APs (223,224,238,240), if interpreted as characteristics, should be interpreted as “as to be” data, as they are requirements and specifications used to control manufacturing conditions, but again, in terms of AP238, there is no data placeholder for specified characteristics.

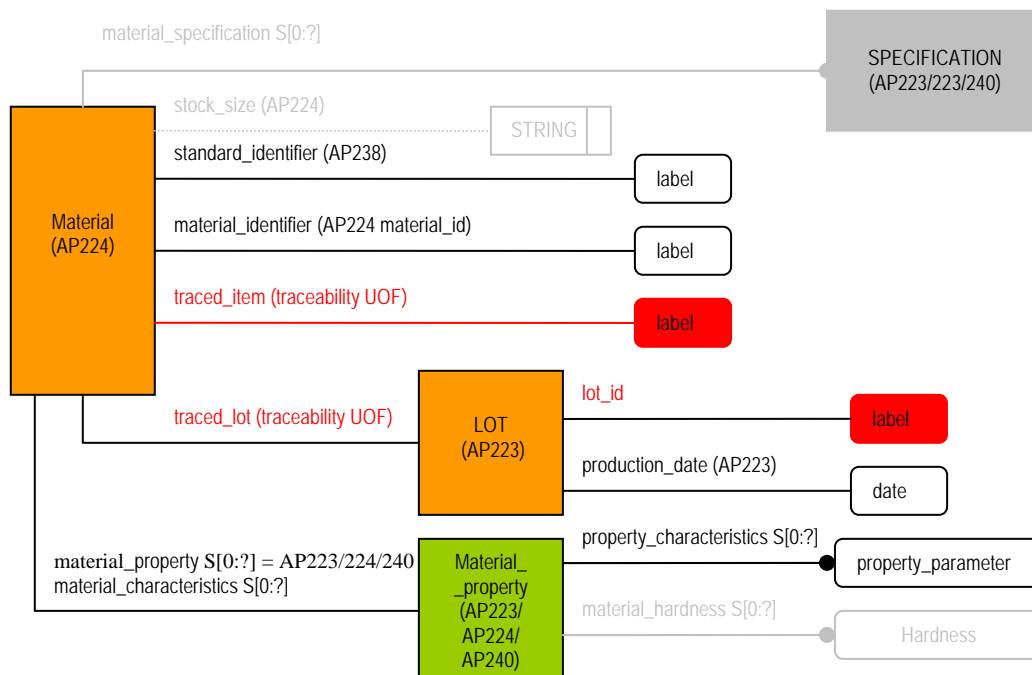

Figure 5. Proposed harmonized version for Material Entity in AP238.

Figure 5 show a harmonized material entity, where AP238, material_property has been added an additional level of indirection, through Material_Property entity, to harmonize like concepts with AP223, AP224, AP240 materials. Inclusion of greyed entities should be discussed. For instance, material hardness could be considered as an specialize Material property characteristic, and at NC-manufacturing level this specification could be no relevant. Moreover, the inclusion of these entities would force to include many others.

It is important to note also here the distinction between material_identifier and standard (they identify the type of material used: as for example in AP223: *"The material_id specifies a word or group of words that make up the unique designation of the material."*), and the added LOT/ITEM identifiers needed for traceability purposes, identifying the batch of used material and possible the concrete unit in this material lot.

PART 3. PROCESS TRACEABILITY PROPOSAL.

3.1 Adding Traceability Capabilities to NC-Machines.

Traceability (and characteristics data) is to be automated and embedded in AP238 STEP-NC. So NC-machine programs must provide resources (control code) to execute traceability recording. These operations or (**traceability workingsteps** ??) should be configured to be traced, and therefore translated into NC-executable instructions in AP238, to be executed by the NC-machine when manufacturing the piece (figure 6).

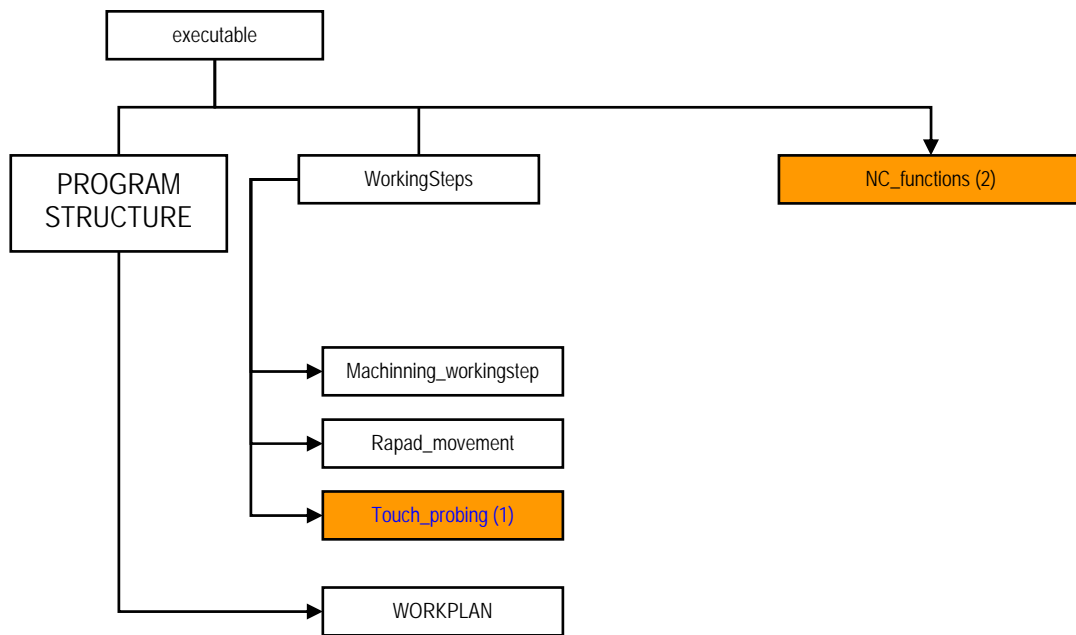

Figure 6. Some Identified actions to be performed by a NC TRACEABILITY-enabled machine. (axis movement operations)

There could be a great number of data recording operations for both traceability and characteristics that can be performed through "Touch_Probing" workingsteps. These data recording operations(1) would include all kind of operations which imply machine axis movement to perform the recording operation. However there are other set of operations that could be performed by the NC-controller, which don't imply machine axis movements, and they could be also grouped under the NC-functions. Figure 7 and 8 details some of the already identified actions, as for example:

get_time : that will instruct the controller to get current time for and register this data in the associated traceability data placeholder for the selected operation. This code should be used for registering starting and ending times for traced operations, as figure 7 depicts, for example for registering the starting and ending time of a workingstep.

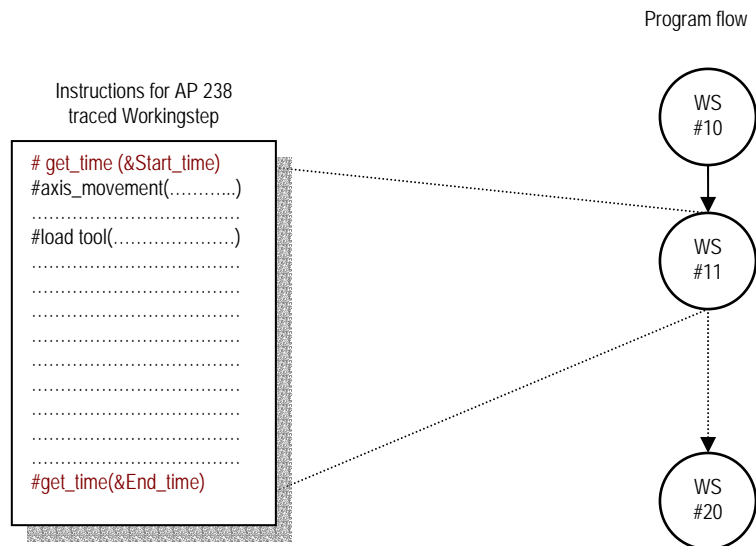

Figure 7. Getting Workinstep Execution Time.

get_tool_data : as NC-controllers have access to the tool database, which must contain all information necessary for identifying the employed tool, it could be functions to allow translate this information into traceability data.

get_Non_Machinning_Data: more generic execution instruction to get for example, the codebar, identifying the worker which has manipulated the NC-machine, etc.

more to_be_defined... ?

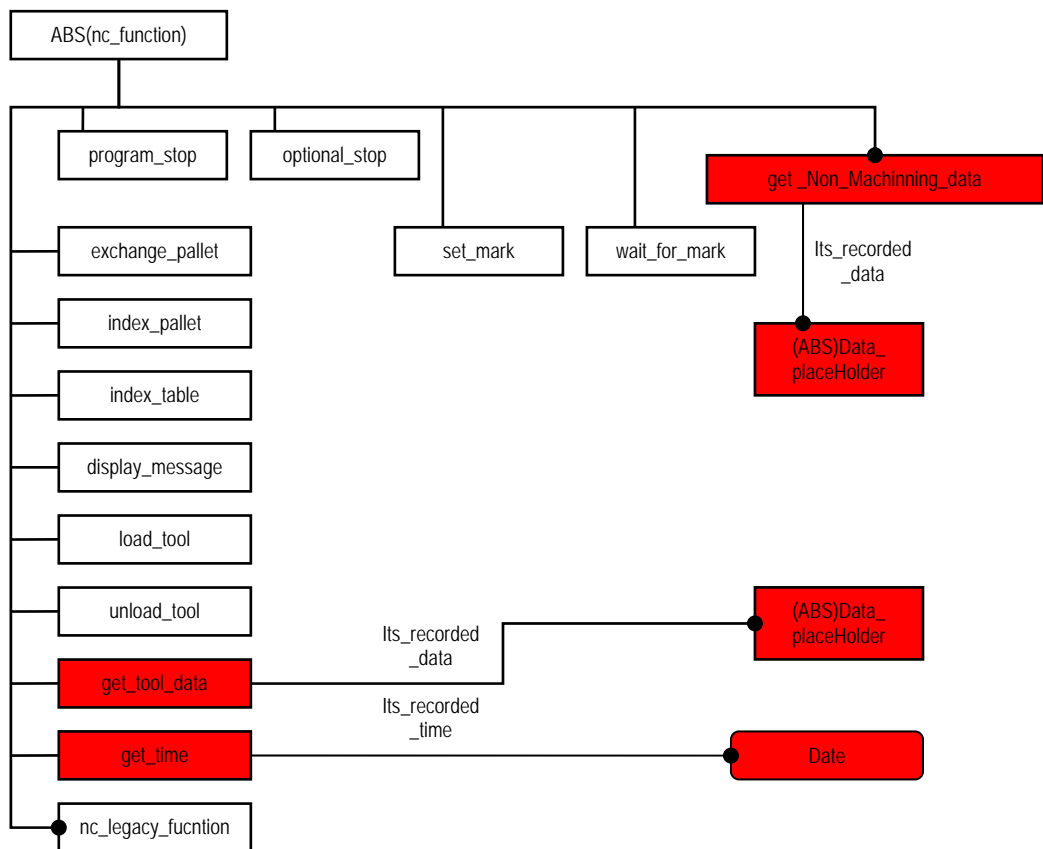

Figure 8. Some Identified Actions to perform by a NC TRACEABILITY-enabled machine. (non-axis movement operations)

3.2 Tracing controller events.

When adding traceability to NC-manufacturing, it is also extremely important to have knowledge of the NC controller running exceptions because, in automation and control systems, problems came, not in the normal cycle execution of the processes, but when the cycle stops. This may happen because there is an Alarm or because the operator decides to stop it (to don't do nothing, just wait, or to make a manual operation). When the process resumes, it may continue in the same point before it had stopped or it may go back to a previous execution point, depending on the control program decisions.

But, every control program is different one from other, one has an auto mode, a manual mode and a stop mode; other have also an alarm mode, etc. Just for clarification, and as an example, see Figure 8.

- Automatic mode: the controller execute the program.
- Manual mode: the controller do not execute the program and only make specific actions in response to manual commands.
- Alarm mode. If a Alarm show up. The controller stops the execution. To go on, the alarm has to disappear and the operator has to "ack" and resume the process.
- Stop mode: some times the execution just stops because a manual decision.
- Warnings: There are soft alarms that do not halt the execution of the automatic mode.
-

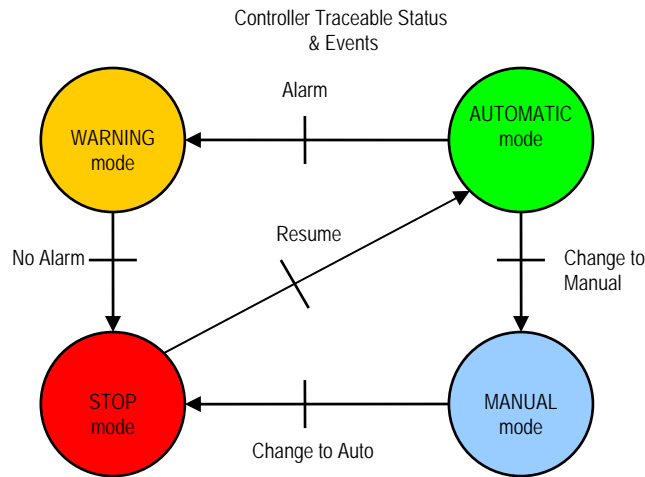
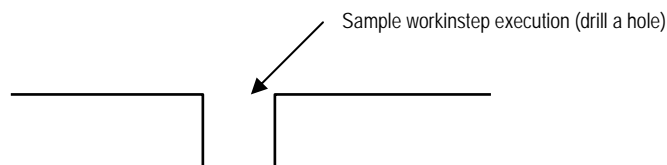
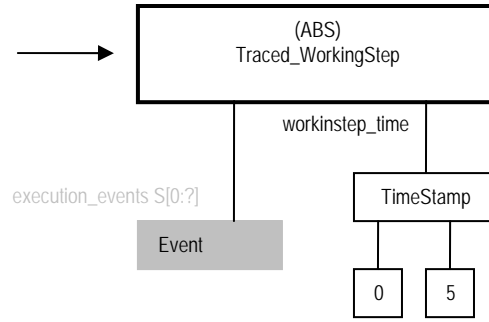
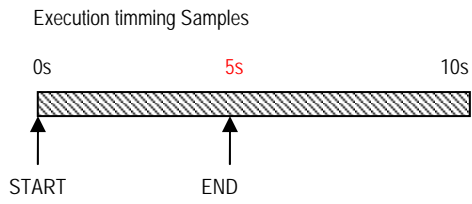

Figure 9. Example of the controller state modes

But, although there is not a common structure for "operation mode" schema, to really know in the future what has happened during production it is very important to track these stops, (and it is enough, it is not necessary know the internal mode organization of the controller program) to know the source of the stops, to know what has happened during the stop time (for instance, if a manual operation has been performed), and to know how the process has continue. Next figure (Figure 10) is an example of possible execution events while making, for instance, a drill workingstep.



1. NORMAL EXECUTION



2. EXECUTION with WARNINGS (no stop)

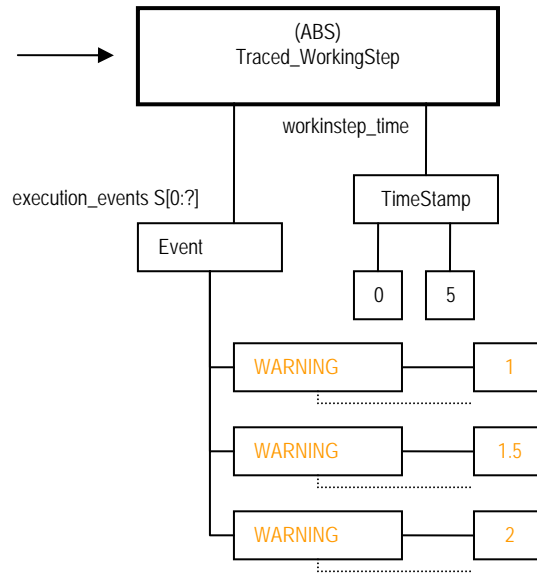
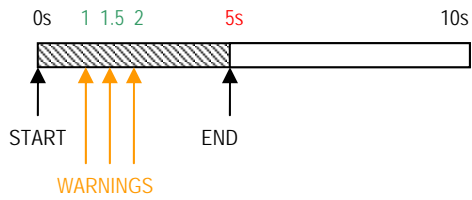

3. EXECUTION WITH ALARM (stop & resume)

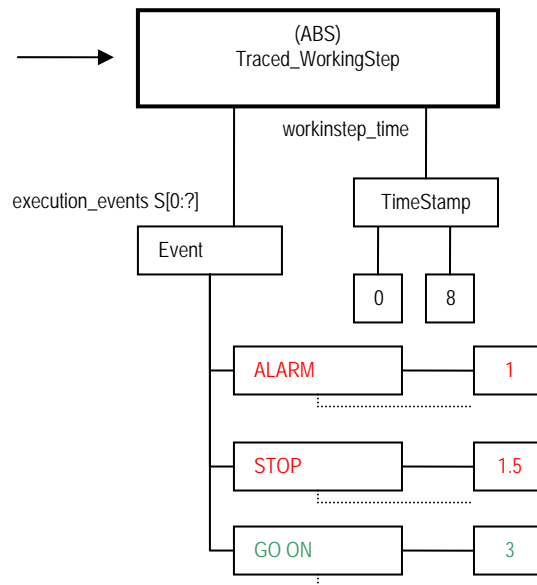
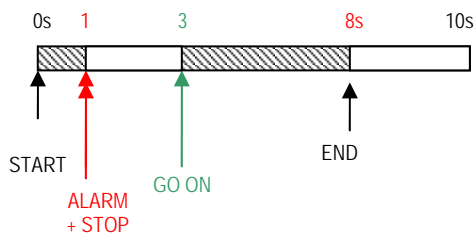

4. EXECUTION WITH MANUAL GO THROUGH

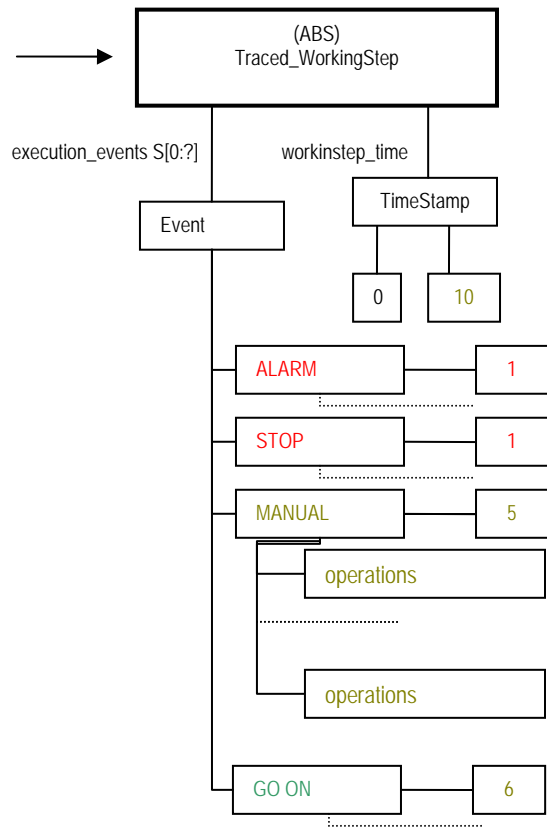
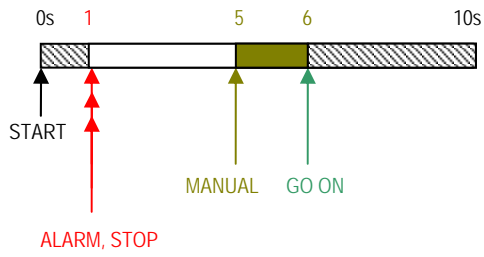

5. FAILED EXECUTION (stop & exit)

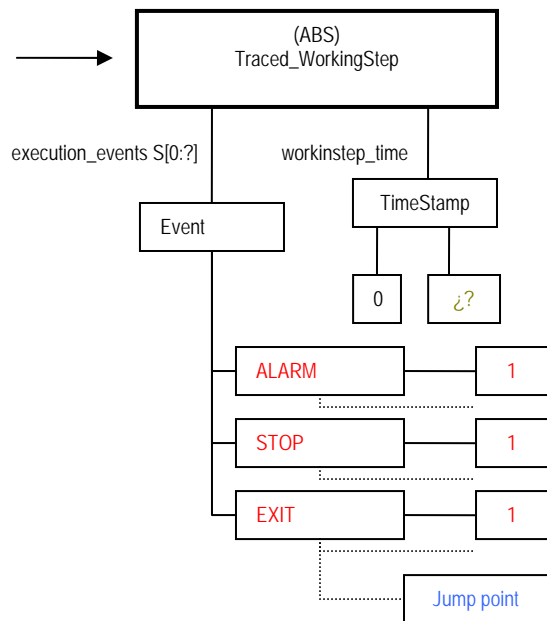
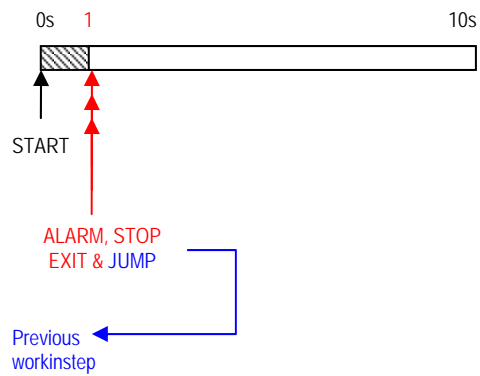

6. EXECUTION WITH RESTART

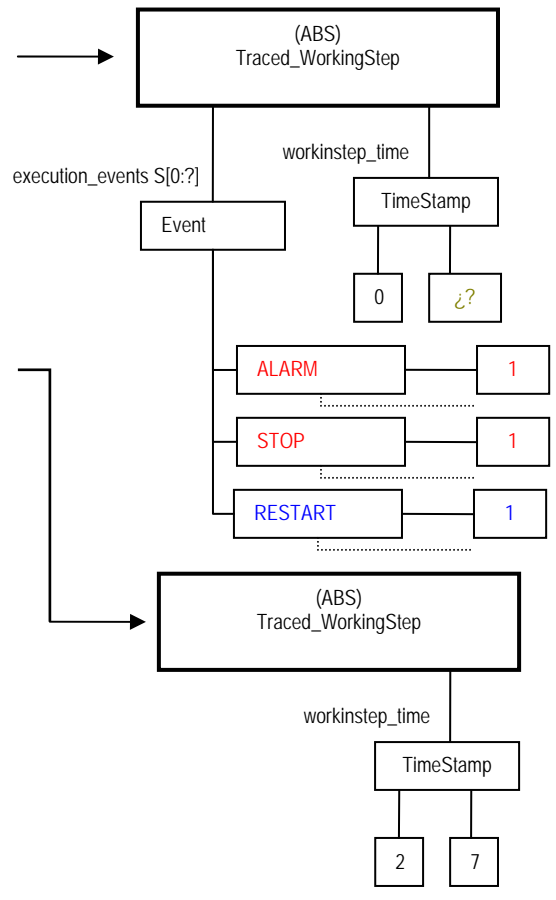
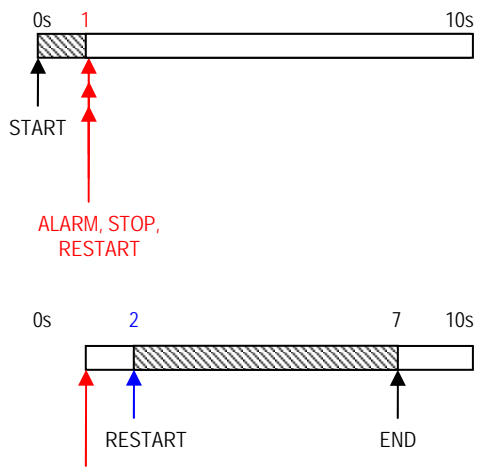

6.1 EXECUTION WITH RESTART & CHANGE TOOLS

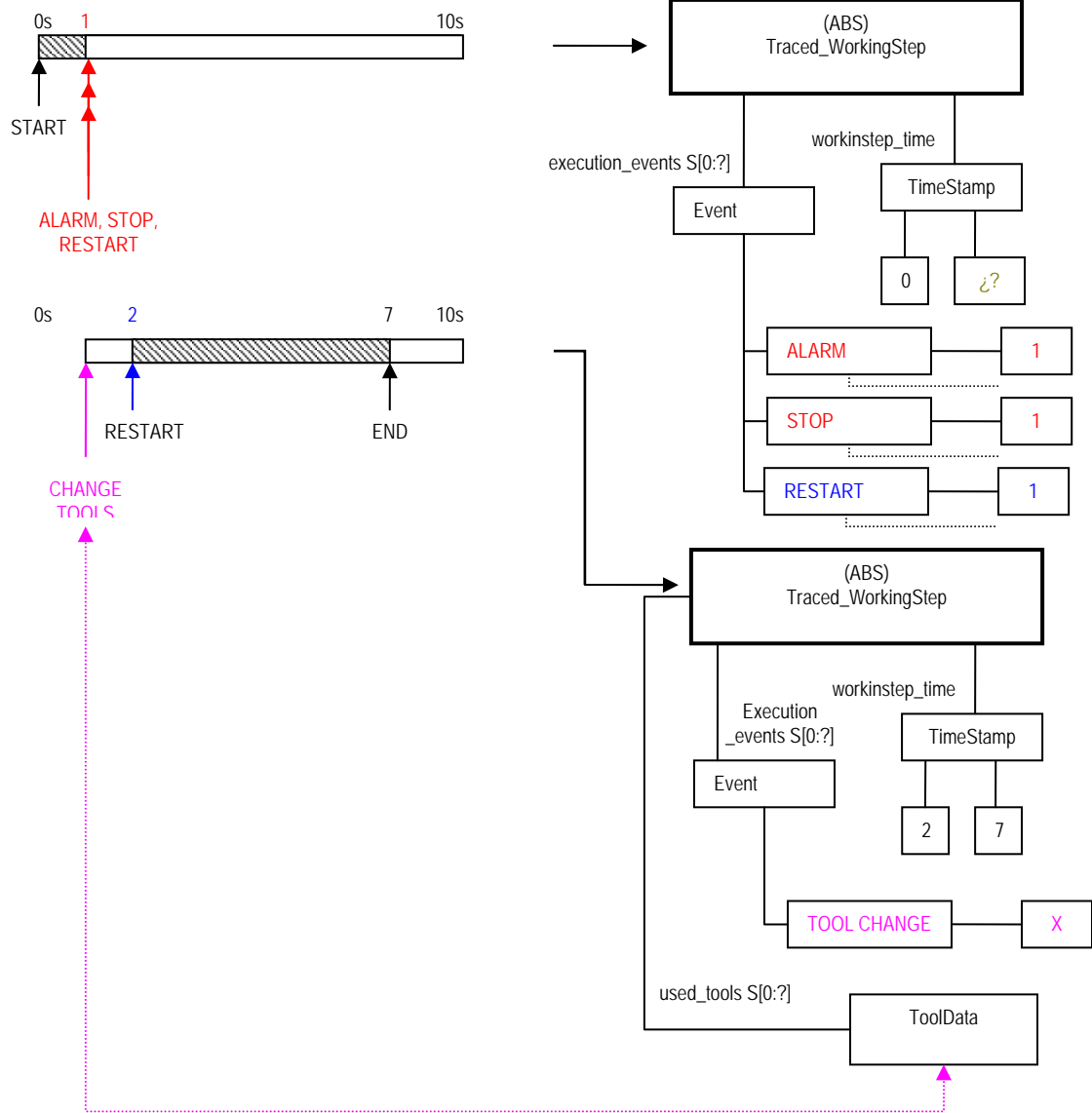

Figure 10. Controller events.

3.3. Modeling process traceability proposal into AP238 ARM.

WorkPiece UOF specifies the mechanical product that is to be produced by a machining program. This description may include material, surface condition, features and the **AS-IS** and **TO-BE** shape of the product. An AP238 Project can have several workpieces, and then, Traceability should be as per **MANUFACTURED PRODUCT** basis (figure 11).

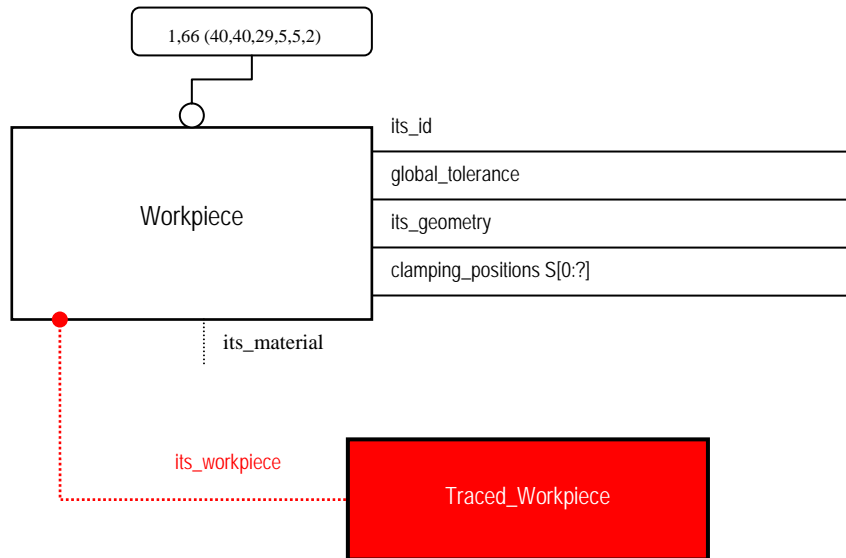
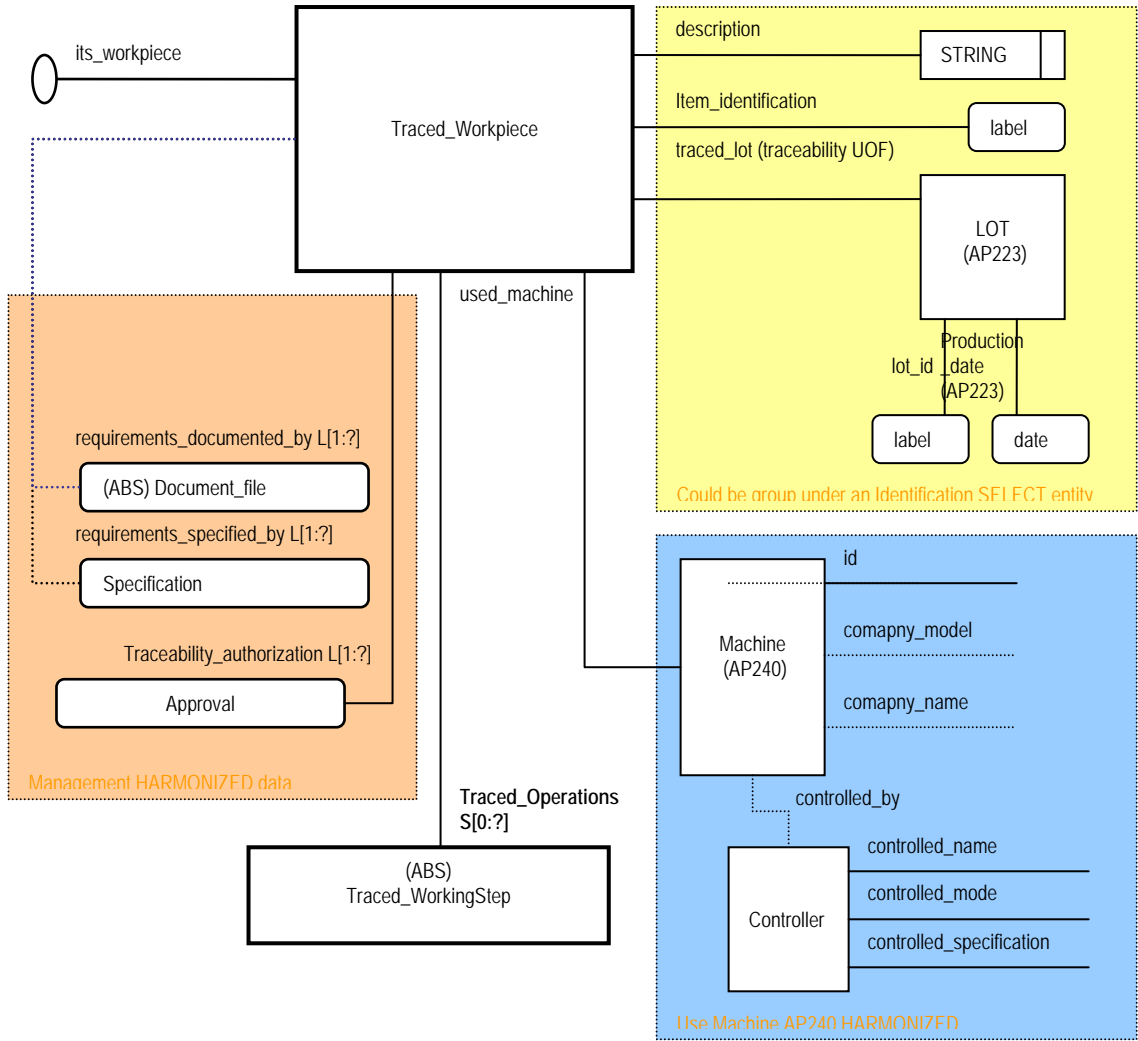
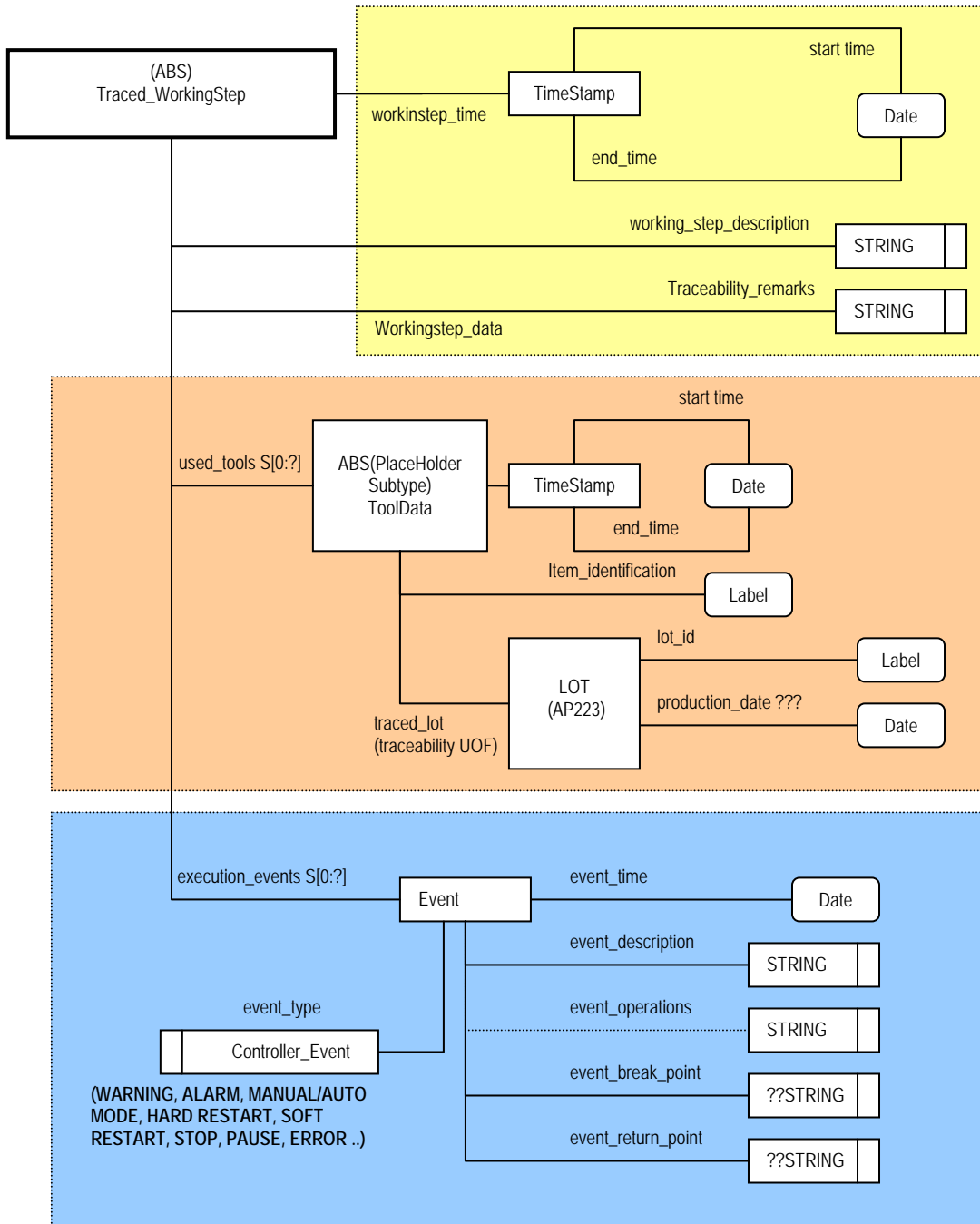

Figure 11. Main Entry point for traceability Data in the AP238 ARM Schema.

Traced_Workpiece is Linked to a **Workpiece**, specifies the physical_identification of the produced Piece. It gives a TRACEABILITY VIEW of the manufactured product. Next two figures expand this entity.





PART 4. Open Questions.

4.1 Is the proposal about using properties (part 1) to handle characteristic data fine? (if it is, it means that AP224,223,240 properties have to be included in AP238).

4.2 Is the proposal (part 2) about redefine material definition (harmonized and extended) fine?

4.3 Is the proposal (part 3.1) about including traceability executable actions (get_time, get_tool_data, ...) fine?

4.4 Is the proposal (part 3.2) about tracing controller events fine or it goes to much beyond the scope?

4.5 To make traceability requirements configurations, for example, to communicate those characteristics has to be trace, or a feature process, etc), it could be some options:

1. Make a kind of conformance classes, for example:

CNC without tracing.

CNC with characteristic tracing.

CNC with resources tracing (material, tools, etc)

CNC with process tracing.

CNC with full traceability.

....

2. Set a boolean attribute in every traceable entity to specify it should be traced or not.

3. Both

4. ¿????.

PART 5. Appendix.

A1: More Harmonization graphics

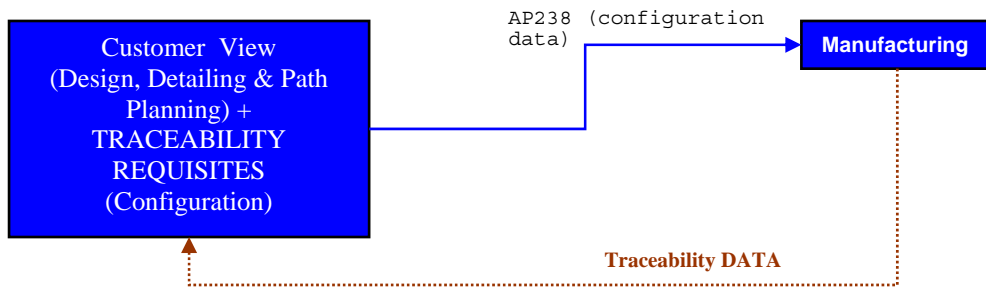
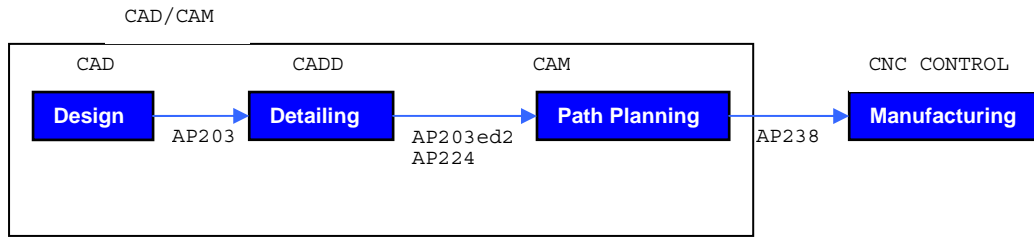

Framework for traceability application in STEP-NC.

AP224/203Ed2 + AP240 + AP238		
<i>Part Model</i>	<i>Shape Representation</i>	<i>Features</i>
<i>Properties</i>	<i>Tolerances</i>	<i>Materials (Process Planning View)</i>
<i>Machine Tool Resource (Process Planning View)</i>	<i>Administrative Data</i>	<i>Process Plan & Process Activities</i>
<i>Process Requirement Documents + TRACEABILITY Requirement Documents & DATA</i>	<i>Milling Turning & EDM Processes</i>	

A STEP Manufacturing "all inclusive" data environment.

AP238		
		<i>Features</i>
	<i>Tolerances</i>	
<i>Properties (Characteristics Data)</i>	<i>Administrative Data (Management UOF)</i>	
<i>Traceability requirements Data</i>	<i>Milling, Turning & EDM Processes (ISO 14649)</i>	

AP238 Information requirements needs for traceability & characteristics data.

A2: Traceability Activity Model

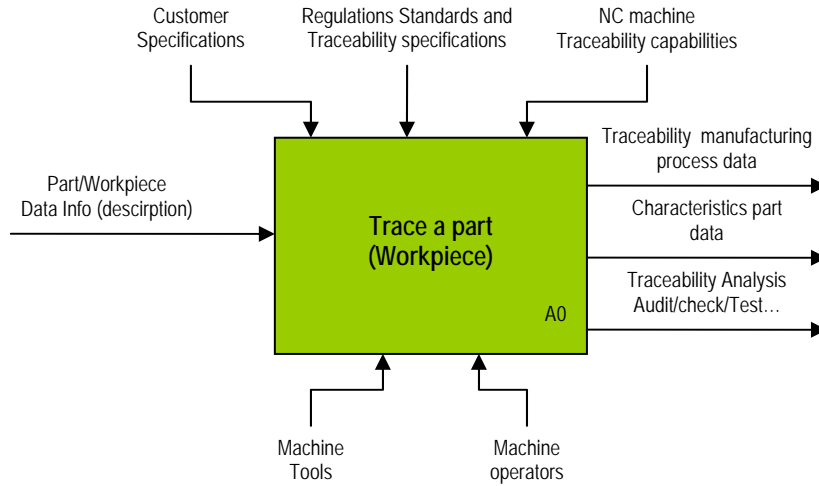

Trace Process in STEP manufacturing Activity Model (Preliminary)

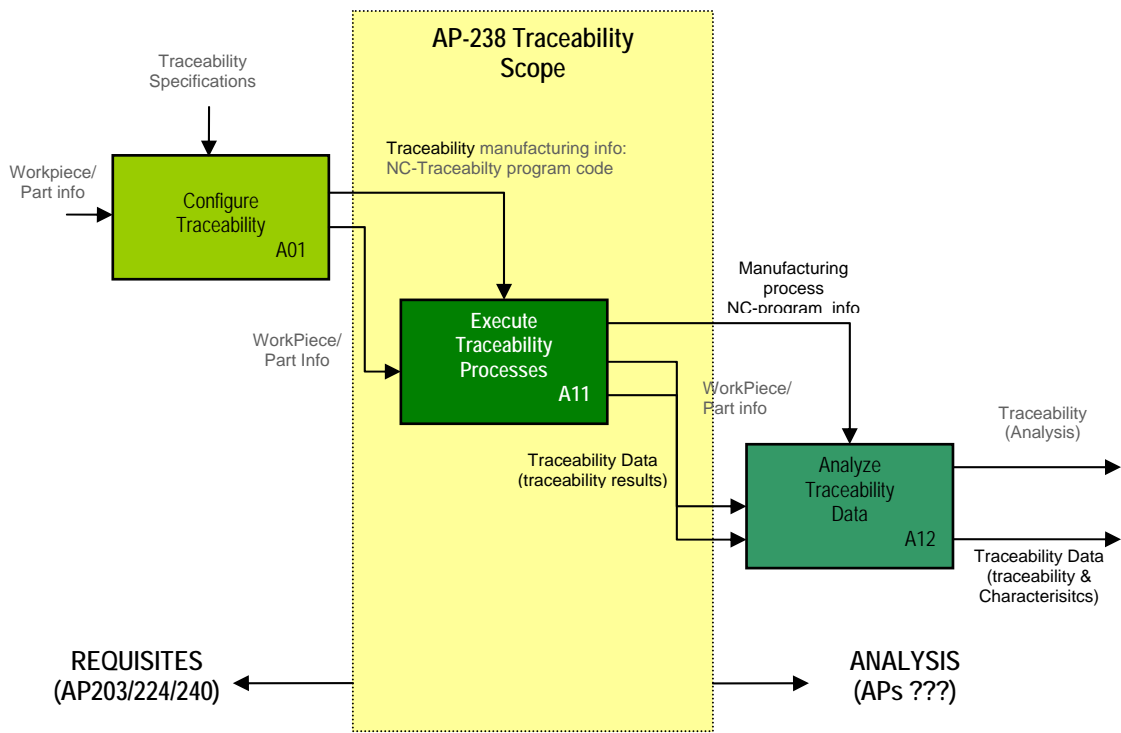

Activity Model detail. (Preliminary)

It is important to notice that if for example, logistic information is to be added with traceability data, "Shipping container" data could be added harmonized with the Activity Model presented for AP223. (figure 11)

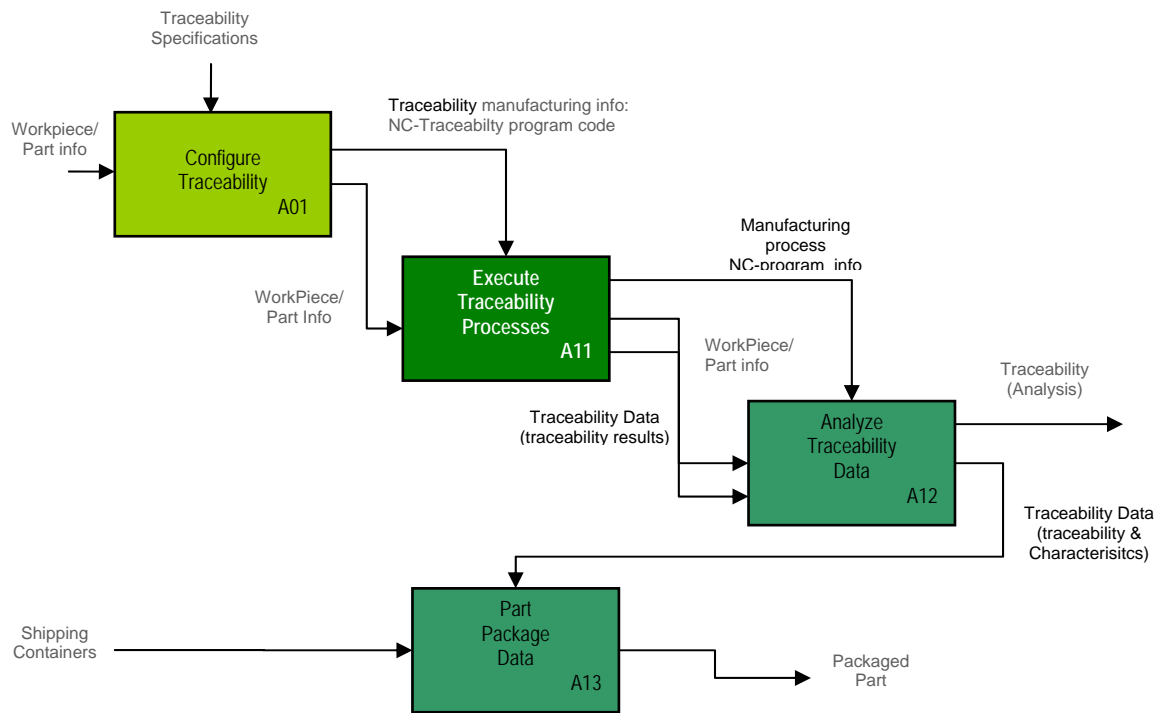

Adding capabilities to the Activity Model detail. (Preliminary)